

Order Code: 100014003

Universal Projector ceiling mount PJ01UCM

Ceiling mount for V, M, P and PA Series

Universal Projector ceiling mount for installation of NEC V, M, P and PA Series projector.

The PJ01UCM is engineered for compact strength and is designed with superior grip adjustment knobs to deliver the easiest fine-tuning for precise image alignment, with the capacity to hold up to a 20kg projector.

While stout and sturdy in structure, this mount boasts premium adjustability and enhanced functionality. No tools are required for image alignment, thanks to the dual-knobs design which provides a hassle-free method for micrometrical adjustment of the gears.

PJ01UCM

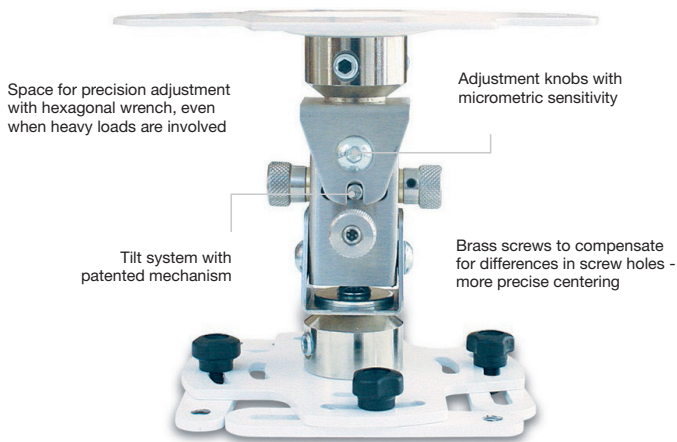

Tilt Mechanism – up to 30°



Optional extension columns Available in white

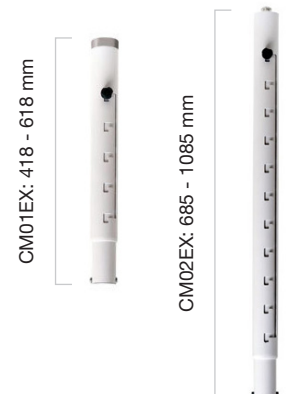

Delivering Genuine Benefits

- Easy fine-tuning for precise image alignment
- No tools required for image alignment
- Integrated cable management through optional extension column for clean appearance
- Adjustable extension lengths with optional extension columns
- Universal adapter plate to fit NEC V, M, P and PA Series projectors
- 5 years warranty

Technical Drawings

Projector Ceiling Mount

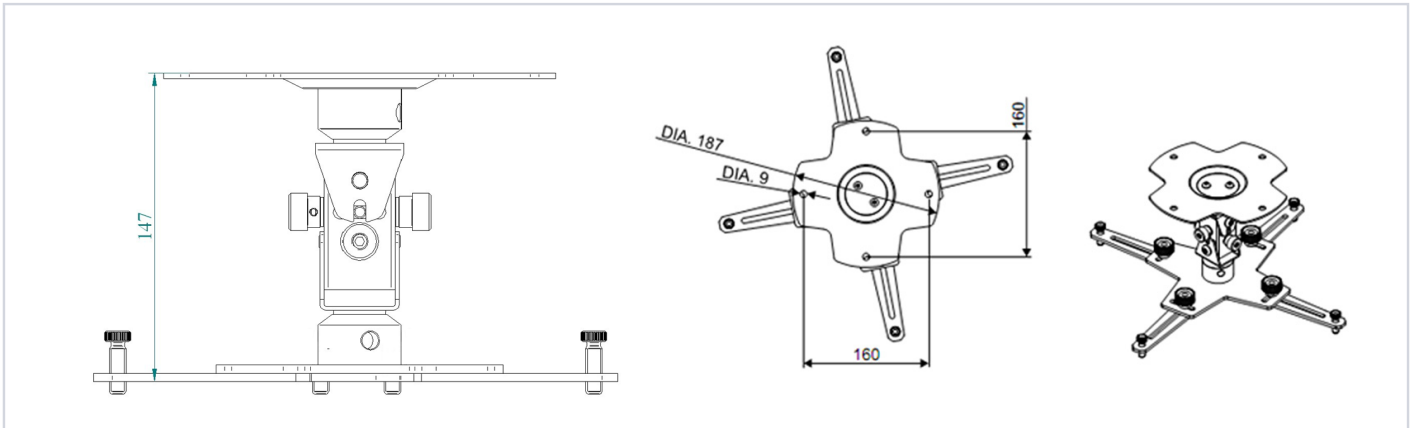

Technical Specifications

PRODUCT INFORMATION	
ORDER CODES	
PJ01UCM	100014003
CM01EX	100014001
CM02EX	100014002
Lenght (Extension Column) [mm]	
PJ01UCM	147
CM01EX	418 - 618
CM02EX	685 - 1085
WEIGHT [kg]	
PJ02CMPX	3.2
CM01EX	1.4
CM02EX	2.1
SHIPPING DIMENSIONS [m]	
PJ02CMPX	0.25 x 0.25 x 0.23
CM01EX	0.09 x 0.09 x 0.47
CM02EX	0.09 x 0.09 x 0.75
MECHANICAL [kg]	
Max. Load [kg]	20
Tilt Angle	up to 30°
Swivel	360°
Colour	White
Shipping Content - PJ01UCM	Ceiling mount (ceiling plate, calibration device, projector adapter plate), 5 x M4 screws, 4 x 105mm adjustable arms, 2 x 150mm adjustable arms
Compatible NEC Projectors	V, M, P and PA Series
Warranty	5 years
For additional pictures and Solutions overview, Visit www.nec-display-solutions.com for details.	* Please consider the overall weight of the complete construction. It is the installers responsibility to make certain the structure to which the mount is being attached is capable of supporting all equipment. For this NEC does not take any responsibility. Please consult your local vendor if advise is needed.

NEC Display Solutions Europe GmbH
 Landshuter Allee 12-14, D-80637 München
 infomail@nec-displays.com
 Phone: +49 (0) 89 99 699-0
 Fax: +49 (0) 89 99 699-500
www.nec-display-solutions.com